

PR LIGHTING



Architectural Lighting 2007





Introduction



Contents

PR Lighting Ltd. is a leading manufacturer of a wide range of lighting products. We have considerable experience in the production of architectural lighting fixtures for both indoor and exterior applications. Our understanding of both aesthetics and functionality has ensured the popularity of our products within the industry. Our commitment to professional products and service stands behind our growing international reputation in the professional lighting field.

Introduction	02
Design 150 Pro	04
Design 250	05
Design 400	06
Design 1000	07
Century Colour 2500L	08
Century Spot	09
Decor I/II/III	10
HeadLight 2500	12
HeadLight 4000	12
Sky Tracer	13
Mega 4000	14
Mega Colour 4000	15



More than ever, the beauty of light and what it can do in an architectural situation is being discovered. Effective lighting can help to re-discover the beauty of the original building and its architecture. It can be used to enhance areas and displays, to give emphasis or prominence and to catch the eye that would otherwise pass unseeing. Architectural lighting is about getting noticed, and here we have a wide range of products to help you do just that.





Design 150 Pro

PR-1151



TECHNICAL DATA

VOLTAGES:

100/120/200/220/230/240V AC, 50 or 60Hz

POWER CONSUMPTION: 200W @ 220V

LAMP:

PHILIPS CDM-SAT 150W/942 discharge lamp

Colour Temperature: 4200°K

Socket: G12

Manufacturers Rated Lamp Life: 6000 hours

Luminous flux: 12900 lm

Or

OSRAM HSD 150/70 discharge lamp

Colour Temperature: 7000°K

Socket: G12

Manufacturers Rated Lamp Life: 3000 hours

Luminous flux: 12000 lm

COLOURS:

CYM colour mixing

With cross fade effect at various speeds

BEAM ANGLE: 21°

SHOOTING DISTANCE: Around 30 meters

CONTROL:

DMX512, 7 channels

Stand-alone control mode: 3 programs

Master/Slave control mode: 3 programs

Static Scene

PRESET MEMORY: 3 preset memories

PROGRAM SYSTEM: 2 user memories

HEAD ADJUSTMENT: Tilt 90° (manually adjustable)

HOUSING: Cast aluminum with paint finish

IP RATING: IP65

LOW TEMPERATURE APPLICATION: Down to -35°C

OTHER FUNCTIONS:

Light level sensor

Timer mode

Remote reset

Lamp control

IN CONFORMITY WITH THE CE STANDARD AND ROHS DIRECTIVE

NET WEIGHT: 17.6Kg

DIMENSIONS: See drawings

GROSS WEIGHT: 21Kg

PACKED DIMENSIONS: 470mm x 390mm x 610mm

PACKED QUANTITY: 1 PC



Dimensions

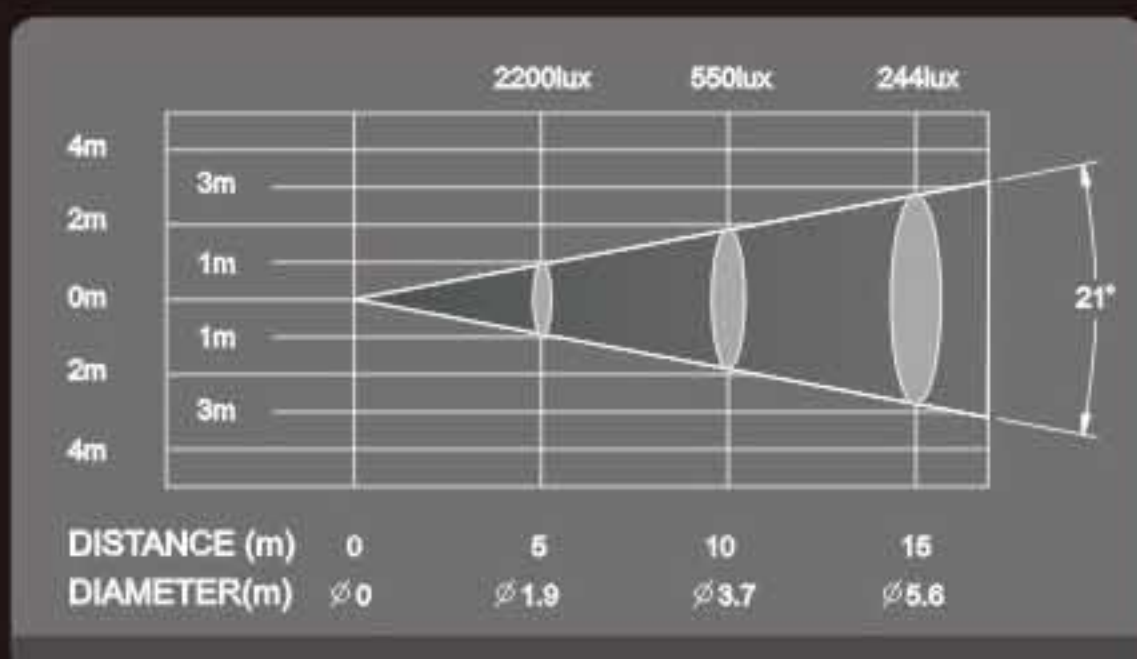



Design 250

PR-1250

TECHNICAL DATA

VOLTAGES:

100/120/200/220/230/240V AC, 50 or 60Hz

POWER CONSUMPTION: 350W @ 220V

LAMP:

PHILIPS CDM-T 250W/830 discharge lamp
 Colour Temperature: 3000°K
 Socket: G12
 Manufacturers Rated Lamp Life: 9000 hours
 Luminous flux: 23000 lm

COLOURS:

CYM colour mixing
 With cross fade effect at various speeds

BEAM ANGLE: 42°

SHOOTING DISTANCE: Around 30 meters

CONTROL:

DMX512, 7 channels
 Stand-alone control mode: 3 programs
 Master/Slave control mode: 3 programs
 Static Scene

PRESET MEMORY: 3 preset memories

PROGRAM SYSTEM: 2 user memories

HEAD ADJUSTMENT: Tilt 6°~90° (manually adjustable)

HOUSING: Cast aluminum with paint finish

IP RATING: IP65

LOW TEMPERATURE APPLICATION: Down to -35°C

OTHER FUNCTIONS:

Light Level Sensor
 Timer mode
 Remote reset
 Lamp control

IN CONFORMITY WITH THE CE STANDARD AND ROHS DIRECTIVE

NET WEIGHT: 20.6Kg

DIMENSIONS: See drawing

GROSS WEIGHT: 23Kg

PACKED DIMENSIONS: 440mm x 500mm x 650mm

PACKED QUANTITY: 1 PC



Dimensions

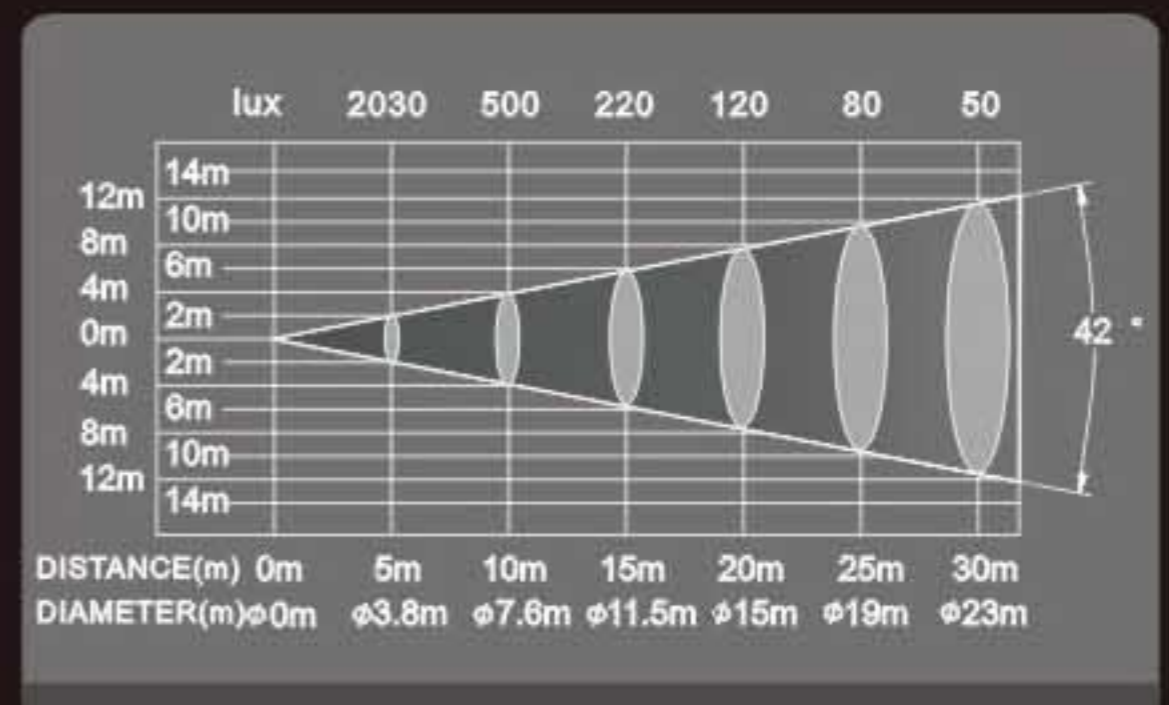



Design 400

PR-1400



TECHNICAL DATA

VOLTAGES: 200/220/230/240VAC, 50/60Hz

POWER CONSUMPTION: 500W@220V

LAMP:

OSRAM HQI-TS 400W/NDL discharge lamp, double ended

Colour temperature: 4200°K

Socket: Fc2

Manufacturers Rated Lamp life: 6000 hours

Luminous flux: 35000 lm

COLOURS:

CYM colour mixing

With cross fade effect at various speeds

HEAD ADJUSTMENT:

TILT 0°-180° (manually adjustable)

BEAM ANGLE: 30° X 60°

SHOOTING DISTANCE: Around 60 meters

CONTROL:

DMX512, 7 channels

Stand-alone control mode: 3 programs

Master/Slave control mode: 3 programs

Static Scene

PRESET MEMORY: 3 pre set memories

PROGRAM SYSTEM: 2 user memories

HOUSING: Die-cast aluminum with paint finish

IP RATING: IP66

LOW TEMPERATURE APPLICATION: Down to -35°C

OTHER FUNCTIONS:

Light level sensor

Timer mode

Remote reset

Lamp control

NET WEIGHT: 26.1 kg

DIMENSIONS: See drawings

GROSS WEIGHT: 30Kg

PACKED DIMENSIONS: 660mm x 500mm x 700mm

PACKED QUANTITY: 1 PC

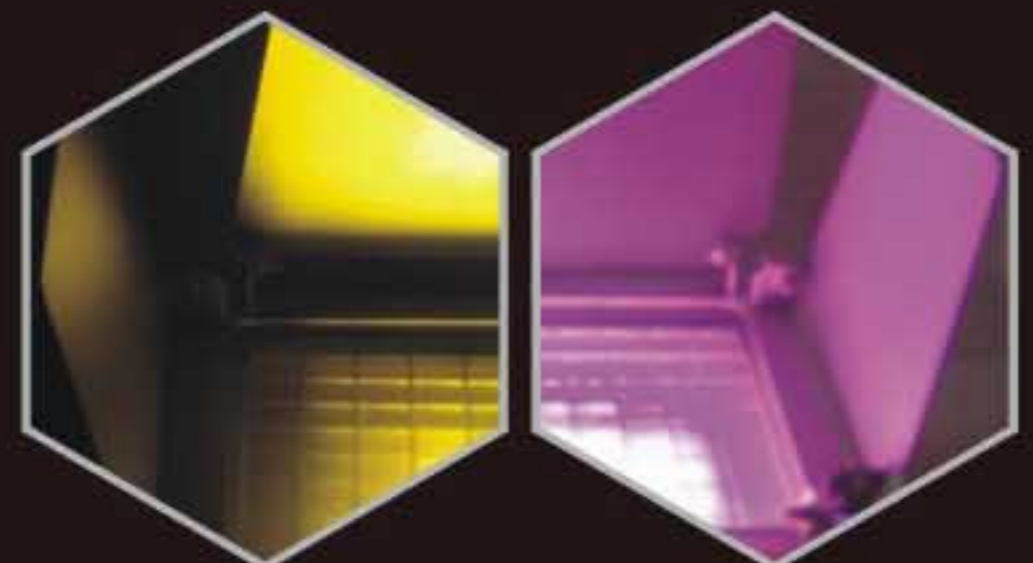

Dimensions

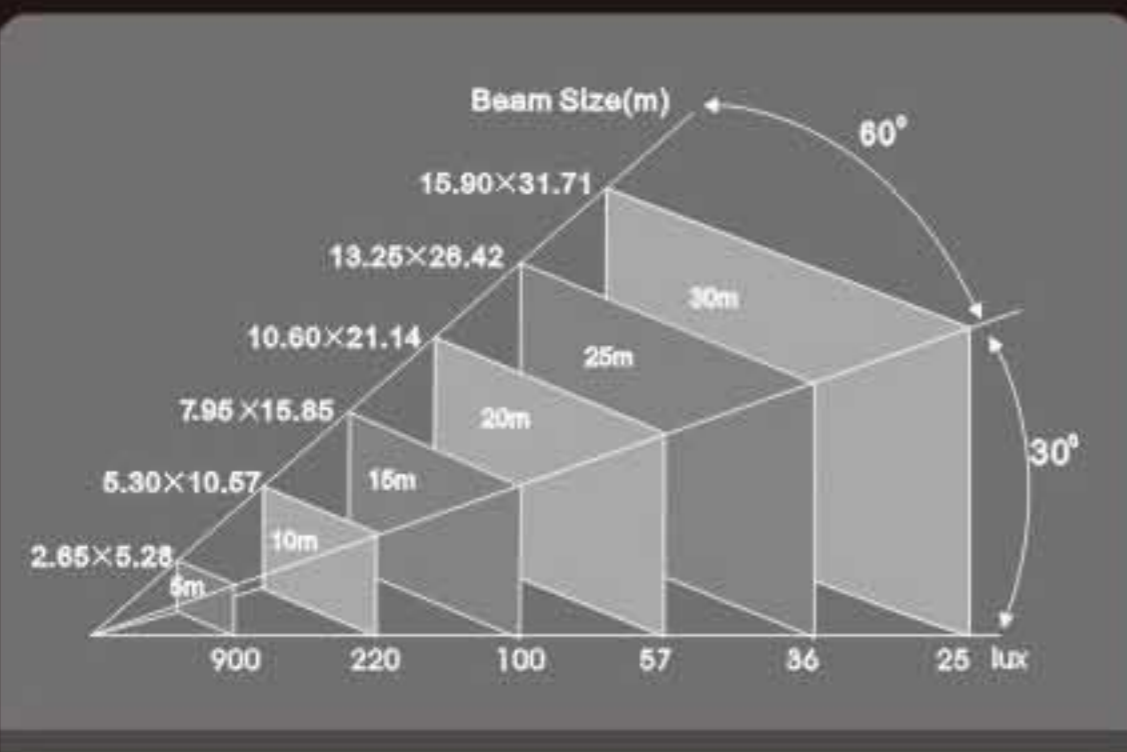



Design 1000

PR-1100

TECHNICAL DATA

VOLTAGES: 200/220/230/240V AC, 50/60Hz

POWER CONSUMPTION: 1180W@220V

LAMP:

OSRAM HQI-TS 1000W/D/S discharge lamp,
 Colour temperature: 5900°K
 Socket: special socket with double ended
 Manufacturers Rated Lamp life: 6000 hours
 Luminous flux: 90000 lm

COLOURS:

CYM colour mixing
 With cross fade effect at various speeds

BEAM ANGLE: 30° X 60°

SHOOTING DISTANCE: Around 80 meters

CONTROL:

DMX512, 7 channels
 Stand-alone control mode: 3 programs
 Master/Slave control mode: 3 programs
 Static Scene

PRESET MEMORY: 3 preset memories

PROGRAM SYSTEM: 2 user memories

HEAD ADJUSTMENT: 0°-180° (manually adjustable)

HOUSING: Die-cast aluminum with paint finish

IP RATING: IP66

LOW TEMPERATURE APPLICATION: Down to -35°C

OTHER FUNCTIONS:

Light level sensor
 Timer mode
 Remote reset
 Lamp control

IN CONFORMITY WITH THE CE STANDARD AND ROHS DIRECTIVE

NET WEIGHT:

Projector: 42.5 Kg
 Power box: 13.1Kg

DIMENSIONS: SEE DRAWINGS

GROSS WEIGHT: 46Kg (body)

14Kg (power box)

PACKED DIMENSIONS: 650mm×640mm×680mm (body)

420mm×280mm×260mm (power box)

PACKED QUANTITY: 1 PC (body & power box)

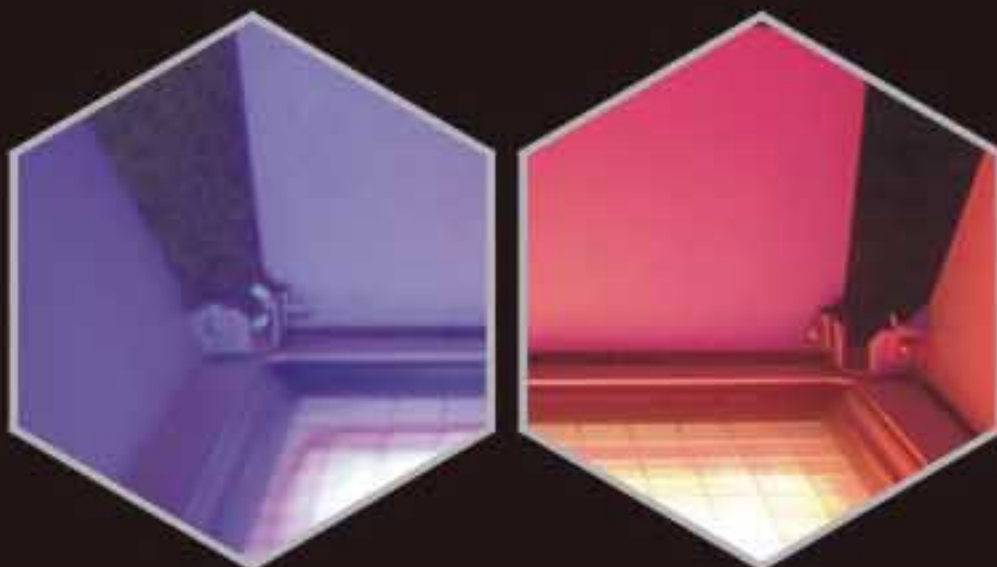

Dimensions

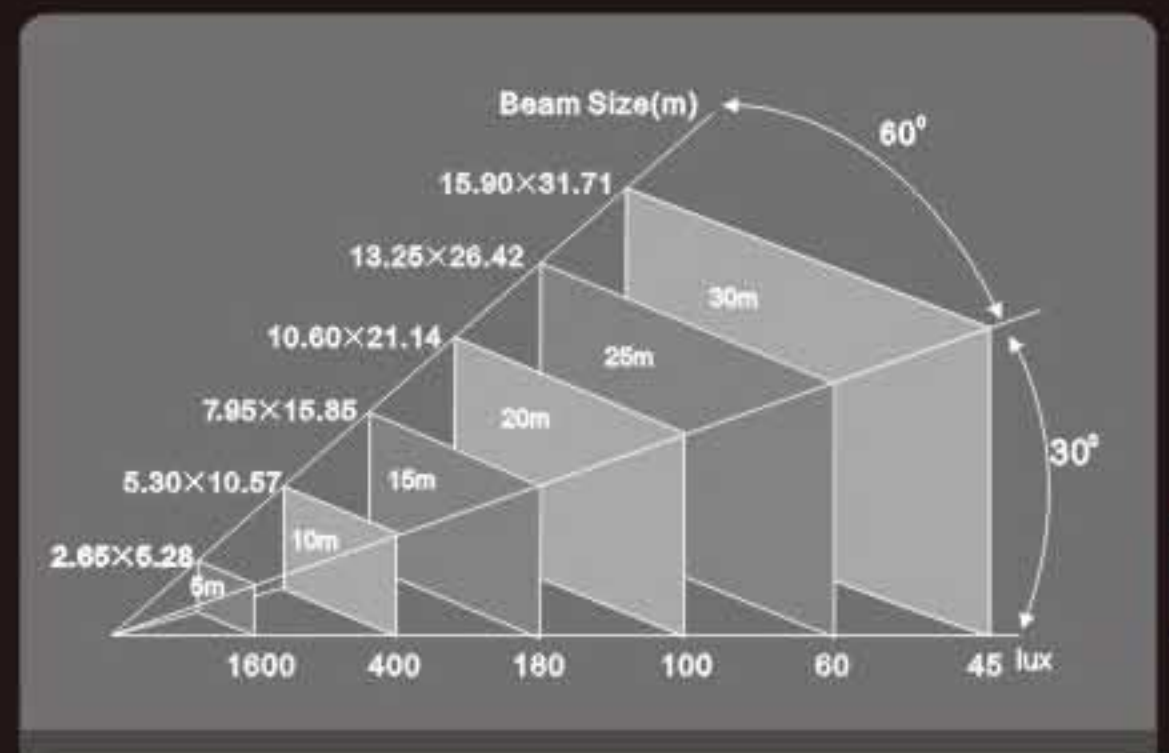
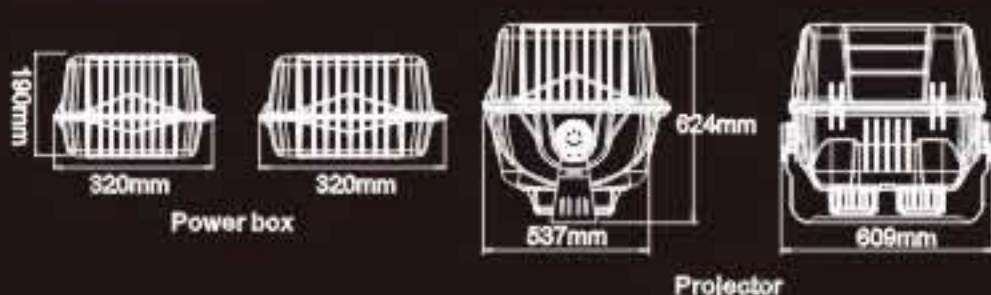

Century Colour 2500L

PR-2001L

TECHNICAL DATA

VOLTAGE: 200/220/230/240V AC 50/60Hz

POWER CONSUMPTION: 2800W @ 220V

LAMP:

PHILIPS MSA2500 DE discharge lamp, double ended
 Socket: (P)SFC
 Colour temperature: 5600°K
 Manufacturers Rated Lamp life: 2000 hours
 Luminous flux: 250000 lm

COLOURS:

CYM continuous colours mixing, white, black-out

BEAM COVERAGE: 60° x 45°

SHOOTING DISTANCE: Around 100 meters

CONTROL:

Standard DMX 512, 7 channels
 Auto program Stand-alone control mode: 15 programs
 Auto program Master/Slave control mode: 15 programs

HEAD ADJUSTMENT: Tilt 90° (Manually adjustable)

HOUSING:

Cast aluminum with silver paint finish and metal plate with epoxy powder paint finish

IP RATING: IP44

OTHER FUNCTIONS:

Linear dimming from 0-100%, thermal cut-off, digital display
 Lamp on/off: remotely controllable

IN CONFORMITY WITH THE CE STANDARD AND ROHS DIRECTIVE

NET WEIGHT: 70 kg

DIMENSIONS: See drawings

GROSS WEIGHT: 82Kg

PACKED DIMENSIONS: 940mm x 650mm x 940mm

PACKED QUANTITY: 1 PC



Dimensions

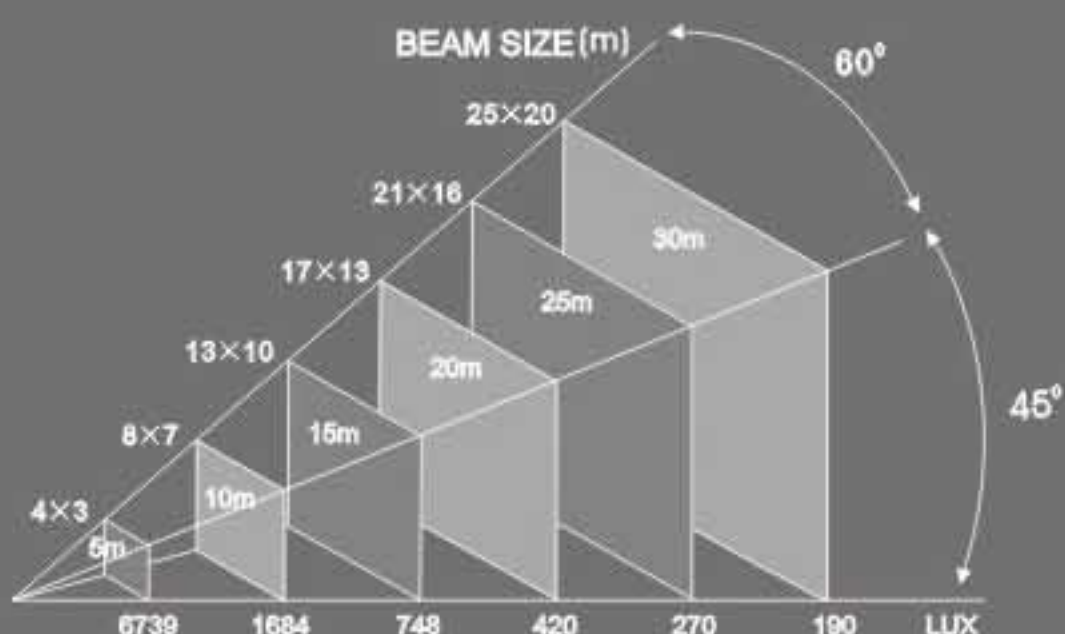



Century Spot

PR-2002

TECHNICAL DATA

VOLTAGE: 220/230V AC 50/60Hz

POWER CONSUMPTION: 2800W

LAMP:

OSRAM HMI 2500W/SE discharge lamp,
 Socket: G38, single ended
 Colour temperature: 6000°K
 Manufacturers Rated Lamp life: 500 hours
 Luminous flux: 240000 lm

COLOURS:

CYM colours continuous mixing, white, blackout

BEAM ANGLE: 12° - 35°

SHOOTING DISTANCE: Around 100 meters

CONTROL:

Standard DMX 512, 6 channels
 Auto program Stand-alone control mode: 7 programs
 Auto program Master/Slave control mode: 7 programs

HEAD ADJUSTMENT:

Tilt 15° ~90° (Manually adjustable)

HOUSING:

Cast aluminum with silver paint finish and metal plate with epoxy powder paint finish

IP RATING: IP44

OTHER FUNCTIONS:

Linear dimming from 0-100%, thermal cut-off

IN CONFORMITY WITH THE CE STANDARD AND ROHS DIRECTIVE

NET WEIGHT: 75 kg

DIMENSIONS: See drawings

GROSS WEIGHT: 87 Kg

PACKED DIMENSIONS: 925mm×625mm×900cm

PACKED QUANTITY: 1 PC

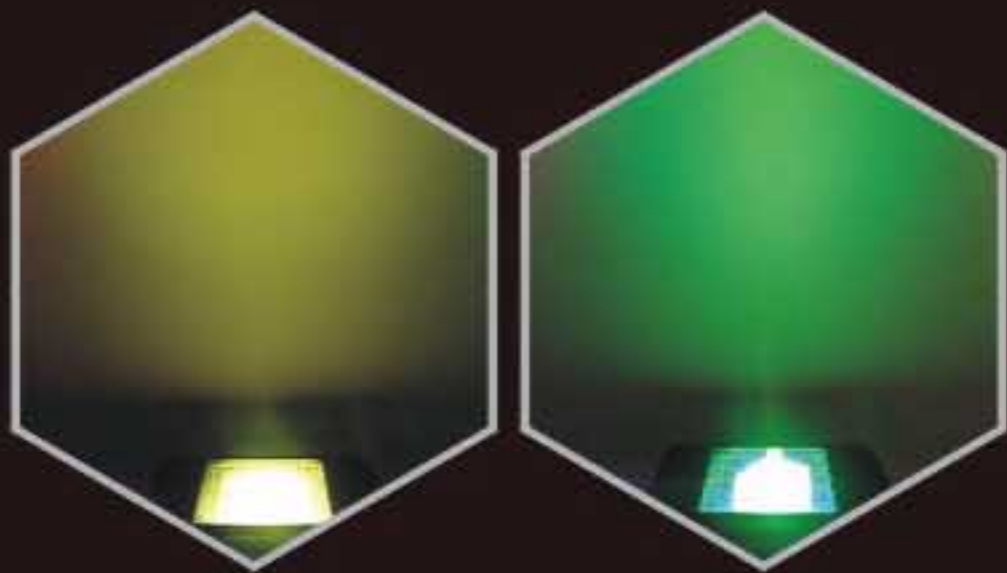

Dimensions

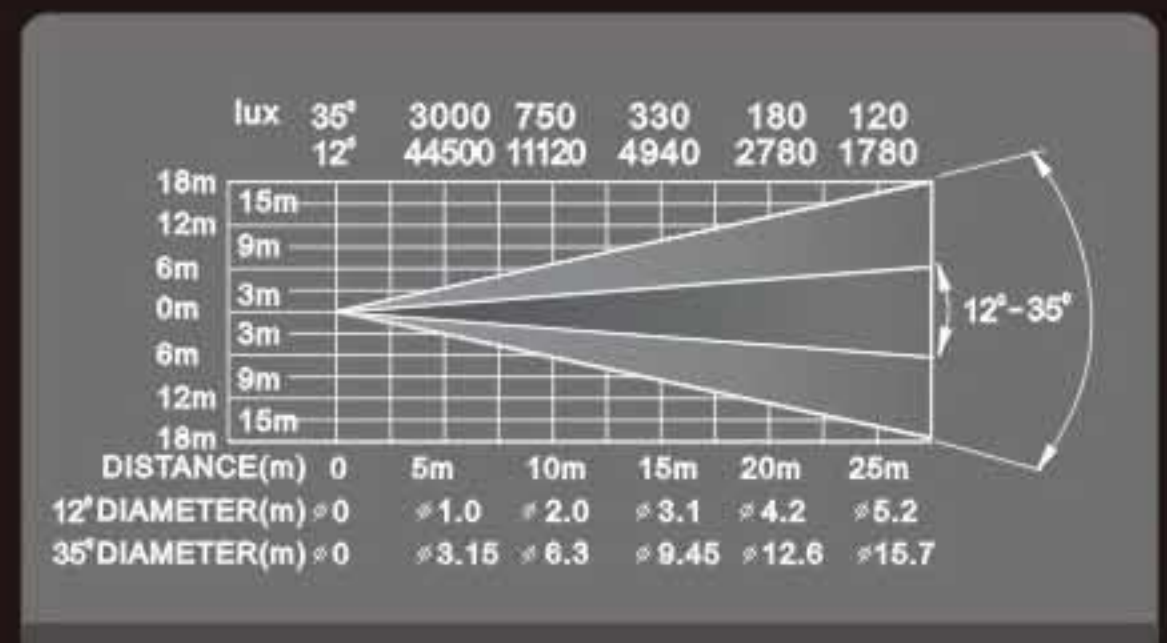



Decor I, II & III

PR-1155, 1160, 1165



Decor I
PR-1155



Decor II
PR-1160

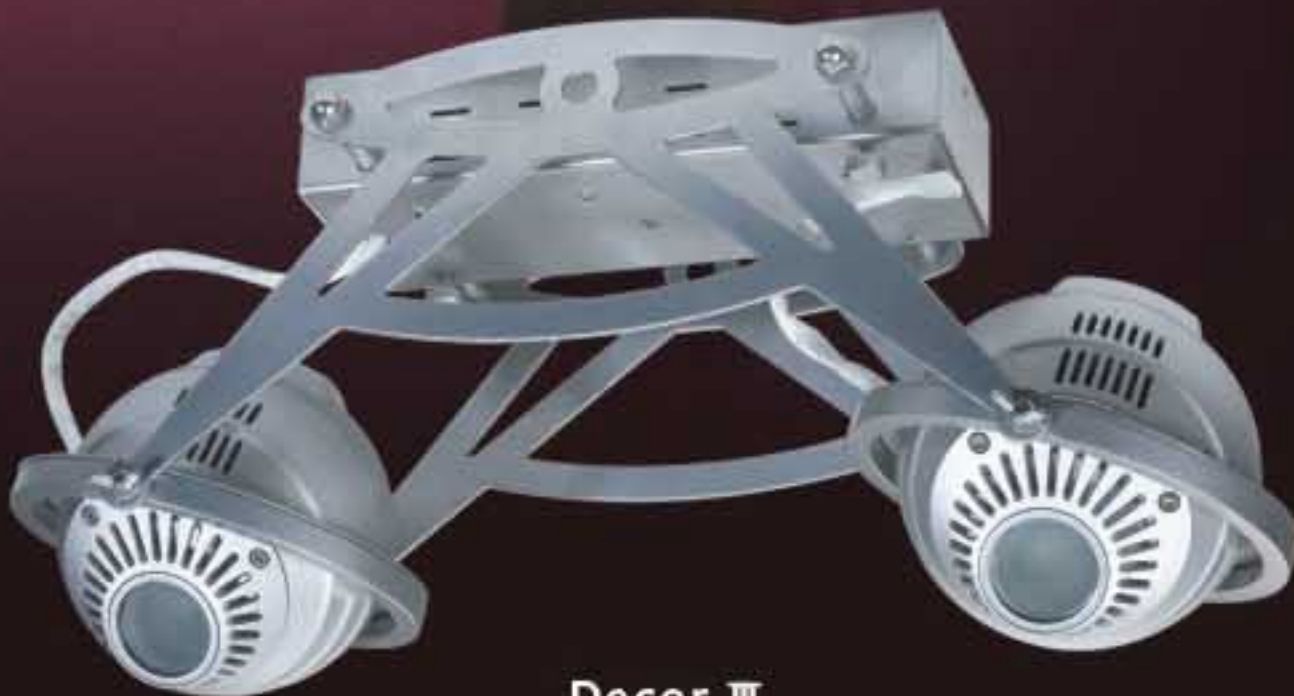

Decor III
PR-1165

TECHNICAL DATA

VOTAGES: 100/120/200/220/230/240V AC 50/60HZ

POWER CONSUMPTION:

Decor I / II: 50W per fixture

Decor III: 100W per fixture

LAMP:

Type: OSRAM DECOSTAR 48870SP 12V/50W halogen lamp

Socket: G.u5.3

Colour Temperature: 3000 °K

Manufacturers Rated Lamp Life: 4000 hours

COLOURS:

6 interchangeable dichroic-filters + 2 CTO + white

Colour-wheel with variable rotation speeds

BEAM ANGLE: 55°

CONTROL:

Decor Control mode through Decor Interface

Standard DMX512 control mode through Decor Interface

USER'S PROGRAM:

Decor Control can store 8 group programs, each program has 24 scenes/steps.

HOUSING: Die-cast aluminum (IP20)

OTHER FUNCTIONS:

Dimmer by electronics

Remote lamp on/off

IN CONFORMITY WITH THE CE STANDARD AND ROHS DIRECTIVE

NET WEIGHT:

Decor I: 1.5Kg

Decor II: 1.2Kg

Decor III: 3.4Kg

DIMENSIONS: See drawings

GROSS WEIGHT:

PR-1155, 2.45Kg (1 packed); 12.3 Kg (4 packed)

PR-1160, 1.9Kg (1 packed); 10.1 Kg (4 packed)

PR-1165, 10.2Kg (2 packed)

PACKED DIMENSIONS:

PR-1155, 330mm×290mm×350mm (1 packed);

660mm×580mm×360mm (4 packed)

PR-1160, 330mm×290mm×350mm (1 packed);

660mm×580mm×360mm (4 packed)

PR-1165, 660mm×580mm×360mm (2 packed)



Dimensions

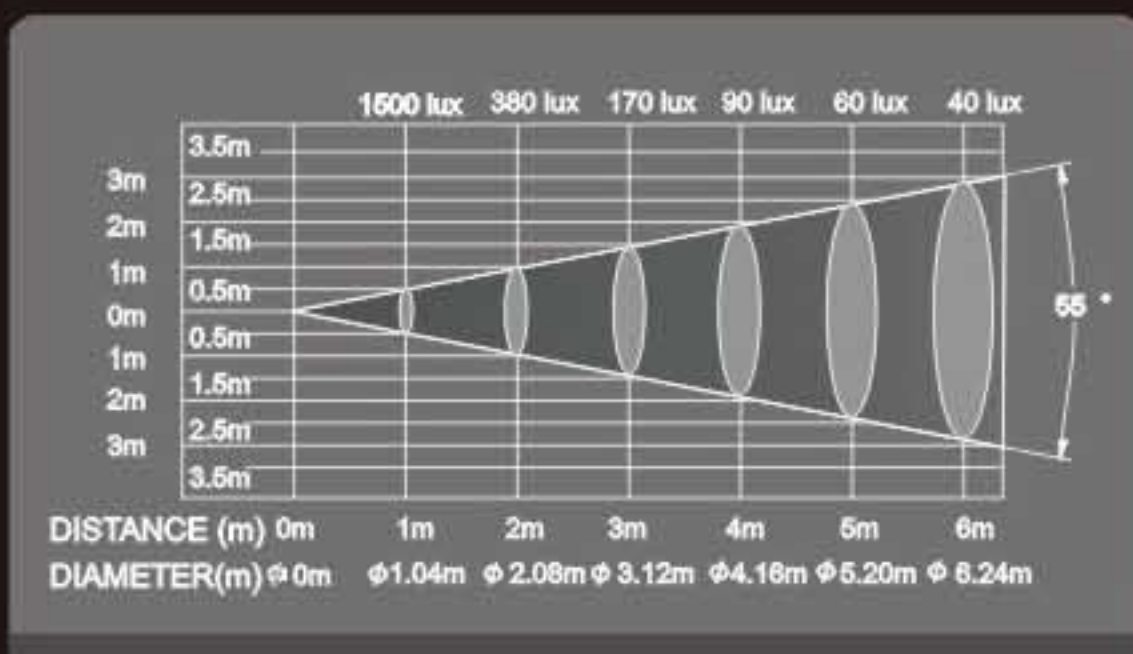



Decor Interface & Controller

PR-1156, 1157

The attractively designed Decor fixtures will give a beautiful touch of colour wherever it is needed, highlighting and bring and bringing to life whatever you choose to emphasise. These units will look good anywhere, from office to bar, from nightclub to museum, the choice is yours.



Decor Interface

PR-1156

The Decor Interface will drive up to 24 single Decor fittings and provides the connection between the fitting and a DMX controller or the Decor Control unit. As with the fittings, two models are available, the EU Model for 185-250V AC 50Hz, and the US Model for 90-130V AC 60Hz, please specify which voltage range you require when ordering.

Weight: 1.5Kg



Decor Control

PR-1157

Conveniently small in size, the Decor Control is designed to be used together with the Decor Interface to program and control the Decor fixtures. It can store eight separate programs of 24 scenes/steps each. Enhancing the simplicity of operation, the front panel has an LCD display. Weight: 0.25Kg.

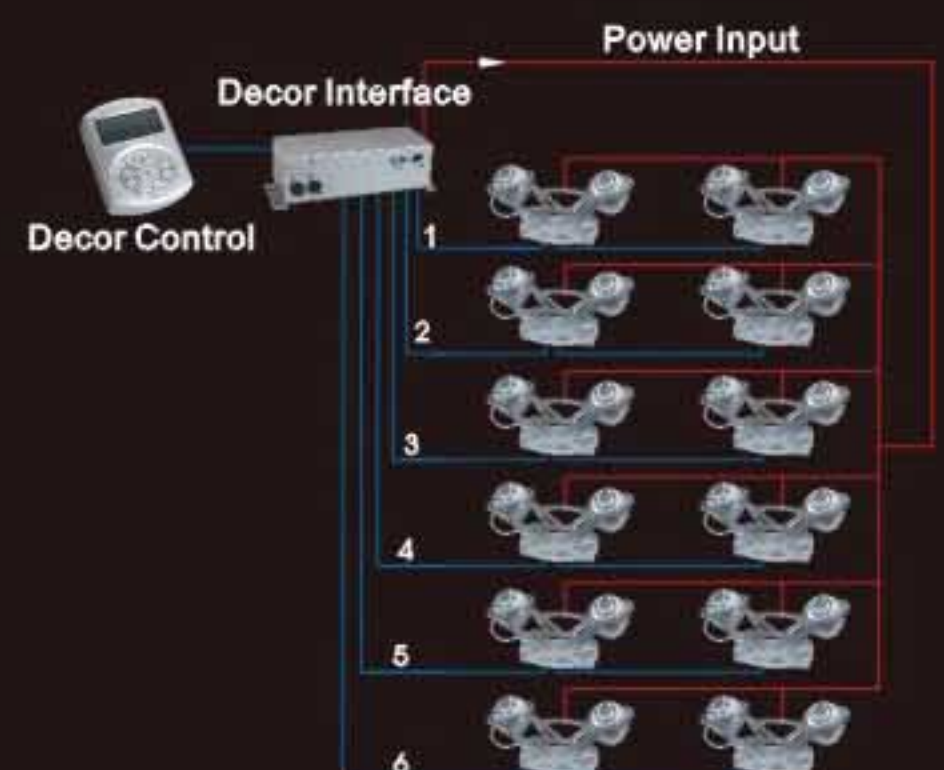

Dimensions





HeadLight 2500

PR-1448

TECHNICAL DATA

VOLTAGE:

400V AC 50Hz

POWER CONSUMPTION:

2800W @220V

LAMP:

OSRAM HMI 2500W discharge lamp
 Socket: Sfa 21, double ended
 Colour temperature: 6000°K
 Manufacturers Rated Lamp Life: 500 hours
 Luminous flux: 240000lm

BEAMS:

32 rotative beams (Beam colours can be ordered)

SHOOTING DISTANCE:

Visible for up to 10 kilometers

HEAD MOVEMENT:

Pan 110°, Tilt manually adjustable through 40°

BEAM COVERAGE:

35°

CONTROL:

Stand-Alone

HOUSING:

Metal plate with epoxy powder paint finish (IP33)

IN CONFORMITY WITH THE CE STANDARD AND ROHS DIRECTIVE

NET WEIGHT:

61 kg

DIMENSIONS:

See drawings

GROSS WEIGHT:

65.2Kg

PACKED DIMENSIONS:

920mm×670mm×890mm

PACKED QUANTITY:

1 PC

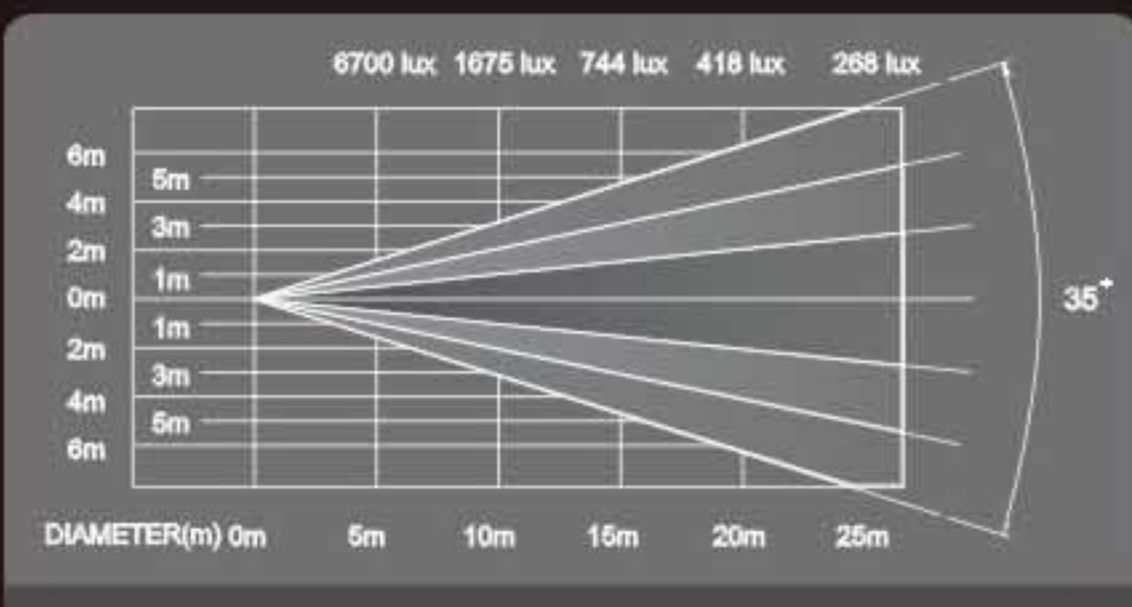

Dimensions





HeadLight 4000

PR-1468

TECHNICAL DATA

VOLTAGE:

400V AC 50Hz (Three-phase power supply)

POWER CONSUMPTION:

4100W@380V

LAMP:

OSRAM HMI 4000W discharge lamp

Socket: Sfa 21, double ended

Colour temperature: 6000°K

Manufacturers Rated Lamp Life: 500 hours

BEAM EFFECT:

35 rotatable beams (beam colours can be ordered)

HEAD MOVEMENT:

Pan 110° Tilt manually adjustable through 40°

BEAM COVERAGE:

35°

SHOOTING DISTANCE:

Visible for up to 10 kilometers

CONTROL OPERATION:

Stand-alone

HOUSING:

Metal plate with epoxy powder paint finish (IP33)

IN CONFORMITY WITH THE CE STANDARD AND

ROHS DIRECTIVE

NET WEIGHT:

85.4 kg

DIMENSIONS:

See drawings

GROSS WEIGHT:

110.4Kg

PACKED DIMENSIONS:

920mm×640mm×910mm

PACKED QUANTITY:

1 PC



Dimensions

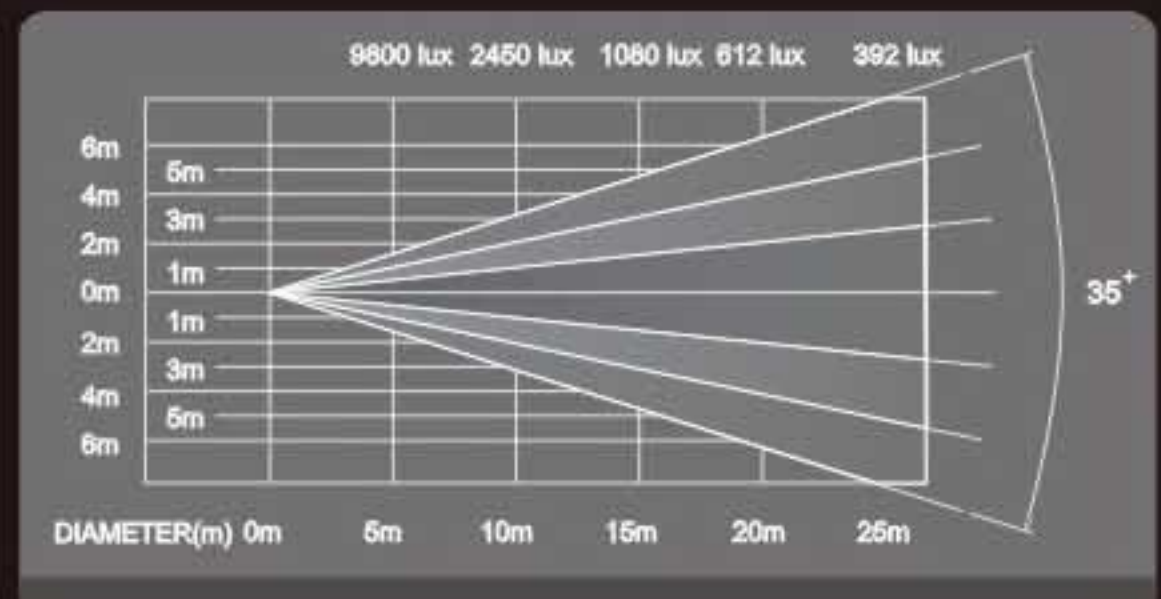
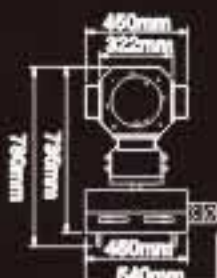



Mega 4000

PR-4000



TECHNICAL DATA

VOLTAGE:

220/230/240V AC 50Hz

POWER CONSUMPTION:

4150W @220V

LAMP:

XQ 4000 Xenon lamp 4000W

Socket: Sfa27-14

Manufacturers Rated Lamp Life: 1000 hours

Colour temperature: 6000° K

Luminous flux: 155000lm

HEAD MOVEMENT:

Pan 180° , tilt manually adjustable through 40°

BEAM ANGLE:

Manually adjustable between 9° and 25°

SHOOTING DISTANCE:

Visible for up to 10 kilometers

CONTROL:

Automatic stand-alone operation

HOUSING:

Aluminum and metal plate with epoxy powder paint finish (IP44)

OTHER FUNCTION:

Safety device for high temperature

IN CONFORMITY WITH THE CE STANDARD AND

ROHS DIRECTIVE

NET WEIGHT:

97kg

DIMENSIONS:

See drawings

GROSS WEIGHT:

135.5Kg

PACKED DIMENSIONS:

950mm×800mm×1240mm

PACKED QUANTITY:

1 PC



Dimensions

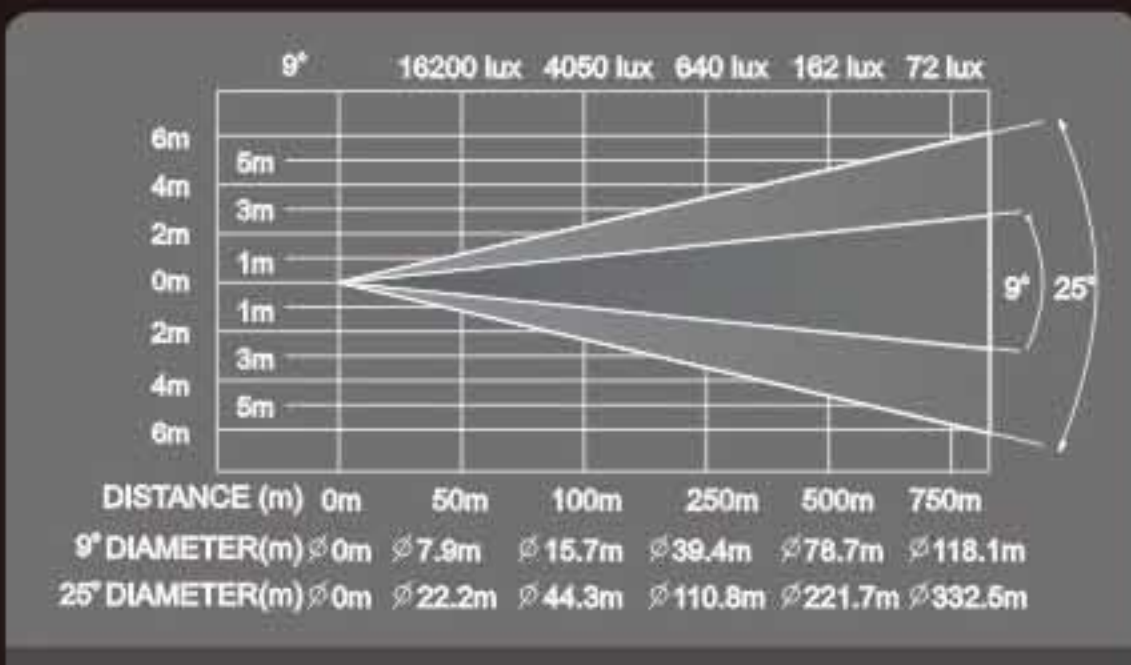



Mega Colour 4000

PR-4100

TECHNICAL DATA

VOLTAGE: 220/230/240V AC 50/60Hz

POWER CONSUMPTION: 4400W

LAMP:

XQ4000 Xenon lamp 4000W
 Colour temperature: 6000°K
 Socket: Anode: Sfa27-14, Cathode SFc27-14, double ended
 Rated lamp life: 1000 hours
 Luminous Flux: 155000 lm

COLOURS: Smooth CYM colour mixing system plus frost

FOCUS: DMX controlled focus

DIMMING: DMX controlled, 0-100% linear dimming

STROBE: 1-17 F.P.S.

CONTROL:

Stand-alone control mode
 Master/Slave control mode
 DMX512 control mode, 3-pin and 5-pin DMX 512 interface
CHANNELS: Short mode: 10 channels, Standard mode: 13 channels

BEAM ANGLE: Parallel beam 0°~25° adjustable

SHOOTING DISTANCE: Visible for up to 5 kilometers

HEAD MOVEMENT:

Pan 400°, Tilt 225° (with photoelectric repositioning system for 16-bit resolution)

OTHER FUNCTIONS:

Programmable functions
 Adjustable Pan & Tilt speed
 Fixture and lamp usage time display
 Overheating protection device
 Adjustable brightness and contrast of LCD display

HOUSING:

High strength aluminum alloy, industrial plastic and composite plastic

IP RATING: IP55

IN CONFORMITY WITH THE CE STANDARD AND ROHS DIRECTIVE

NET WEIGHT: 126KG

DIMENSIONS: See drawings

PACKED IN FLIGHT CASE

PACKED DIMENSIONS: 1010mm×900mm×1530mm

PACKED QUANTITY: 1PC



Dimensions

